

Axial





COMPANY OVERVIEW

Ringo Válvulas (RV) is located in the industrial city of Zaragoza, Spain. Since its establishment RV has designed and manufactured its own cast and forged valves. Our experience of over 40 years on the valve industry is the key to our international success and recognition. We export more than 75% of our production all over the world.

RV activities include the design, material procurement, manufacturing, assembly and testing of valves. We supply Gate, Globe, Check, Ball Plug, Butterfly, Control and Special Valves produced according to different standards (ASME-ANSI, DIN, API, BS), sizes, pressure ratings and materials (Carbon Steel, Alloy Steel, Stainless Steel, Duplex, Monel, etc.).

Our valves are used in many different applications such as Oil & Gas, chemical and Petrochemical, Cryogenic and Power Generation (including Nuclear, Combined Cycle, Thermoelectric and Hydraulic Plants).

RV facilities are modern and fitted with advanced equipment for manufacturing, assembly, testing and inspection. This equipment guarantees the conformity with the most stringent specifications.





Driving Energy

CONTENTS

- Quality. Pag. 4
- Markets. Pag. 4
- Our International Accreditations. Pag. 5
- 01** Axial Flow Control Valve. Pag. 6
- 02** Rax Axial Control Valves. Pag. 7
- 03** Cages Types. Pag. 10
- 04** Codification System. Pag. 12
- 05** Manufacturing Range. Pag. 14





■ QUALITY

Ringo Válvulas is totally committed to Quality and a smooth integration of all departments with the Quality Assurance and Quality Procedures.

Ringo Válvulas holds ISO 9001-2008 by Lloyd's Register as well as PED, ATEX, TUV AD-2000 HPO & WO, EN-ISO 3834-2, Functional Safety Management system (SIL), among others.

This guarantees that all our products are designed, manufactured and delivered in accordance with the most strict customer requirements. Thus we achieve our main goal "to offer a high quality product and service to ensure a high degree of satisfaction and fidelity of our customers".

■ MARKETS

Our valves are used in many different applications such as Nuclear Power Plants, Conventional Power Plants, Oil & Gas, upstream and downstream offshore, chemical, petrochemical, cryogenic, etc.

We export more than 75% of our production to countries all over the world.

Worldwide customer service: We provide spare parts and field engineers to support our customers anywhere.

Ringo Válvulas has been involved in many large international projects carried out by the world's leading engineering construction companies.



■ OUR INTERNATIONAL ACREDITATIONS:



ISO 9001:2008 by LRQA



ISO 14001 by LRQA



OHSAS 18001 by LRQA



API 6A-0729
Licence Nr. 6A-0729



API 6D-0495
Licence Nr. 6D-0495



API 6DSS-0038
Licence Nr. 6DSS-0038



CE stamp holder
PED 97/23/CE



ATEX stamp holder



GOST certificate

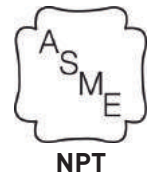

Industrie Service



ROSTECHNADZOR
Certificate



Inspection Type Certificate
issued by INSPECTA nuclear



ISCIR Certificate of
authorization

Certified by TÜV according to EN ISO 3834-2
 Certified by TÜV according to AD 2000-Merkblatt HP 0, TRD 201
 Certified by TÜV according to AD 2000-Merkblatt W 0/A4



01 Axial Flow Control Valve

■ Design of the Axial Flow Valve

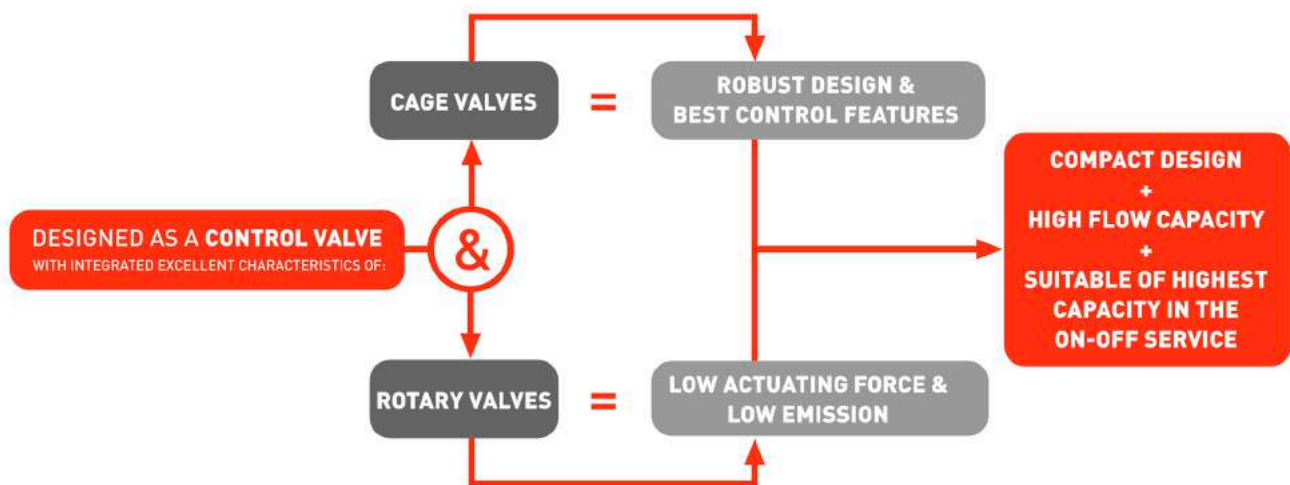

■ Advantages of Samson Ringo Axial Flow Valve

- **Largest Cv value**, combined with high rangeability
- Cage guided balanced plug for smooth operation
- Variety of cage designs to handle gas and liquid critical applications.
- Drive mechanism's multiplier effect give maximum thrust when it is needed.
- Unique Rotary-to-Linear drive mechanism simplifies actuator requirements.
- Standard electric or pneumatic 90° actuator with standard positioner can be used.
- Smooth, precise control .
- Reduced friction.
- Backlash free.
- Environmentally safe: Low emissions due to rotating shaft.
- Drive mechanism is not affected by dirty fluids.
- Reduced force requirements by more than half.
- Higher capacity in the market for same sizes, over 30% in on-off valves.





■ Body materials

Carbon Steel : A216-WCB
 Cr-Mo Alloy Steel : A217-WC6, A217-WC9
 Cr-Mo-V Alloy Steel : A217-C12A
 Stainless steel 18% Cr: A351-CF8M, A351-CF8C
 Cr + Ni Stainless steels: Alloy 20, A351-CK3MCuN
 Duplex A890-Gr. 4A, Super Duplex A890-Gr. 6A
 Nickel based alloys, Hastelloy, Inconel; Monel.
 Titanium.

■ Trim materials

Martensitic : A276-410, A276-420
 Austenitic: A276-316
 Cr + Ni Stainless steels: Alloy 20, A182-F44
 Duplex A182-F51, Super Duplex A182-F55
 Nickel based alloys, Hastelloy, Inconel; Monel
 Titanium.

■ Cladding and Overlays

Stellite: Hardness HRC 45 RC & Maximum working temperature 500°C
 Tungsten carbide: Hardness HRC 74 RC & Maximum working temperature 550°C
 Chromium carbide: Hardness HRC 68 RC & Maximum working temperature 870°C
 Inconel: Hardness HRC 23 RC & Maximum working temperature 700°C



■ Fully tungsten carbide trims

For choke applications or where high hardness is required (dirty fluids with particles).
 Produced by sinterization.

* Any other materials are available on request.

■ Body design

A streamlined body with constant sectional area, offers a very reduced coefficient resistance and gives larger Cv values for the same sizes.

Fluid is channeled into an annular path between the inner and outer bodies until it reaches the characterized cage.

Smooth changes in flow direction and no turbulences contribute to lower noise levels.

The high capacity, combined with the large rangeability, make our axial valve to be acknowledged as the ideal design to control over the full range of process conditions with a single valve.

As an option extended body neck is offered for cryogenic operations.

Low emission is guaranteed by the O-ring seals combined with back-up packing.

Distance between flanges is in accordance with ISA 75.03 when data are available or API 6D for larger sizes.

Actuator flanges are machined according to ISO 5211 or other standards.

All types of quarter turn actuator are easily mounted.

Casted range from 4" to 48" and ratings from 150# to 2500#.

Forged three pieces for sizes below 4" and pressures above 2500#.

Constant flow passage area ensures the maximum possible capacity for on-off application due to reduction of the K resistance coefficient.

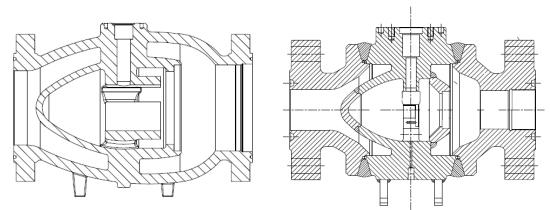

■ Trim design

Advantages of **stem guided** plug:

- Can be used for on-off application without cage in order to achieve high capacity.
- Control is performed by hole pattern.
- Possibility of using multi-cage designs to perform multistage pressure reduction of high noise/cavitation conditions.
- Availability of balanced plugs, to reduce the required actuator torque.
- The inner chamber, which includes the transmission system is pressure balanced, due to that no fluid movement is occurring inside this area.
- Bearings of transmission mechanism are protected against particles by a cover.

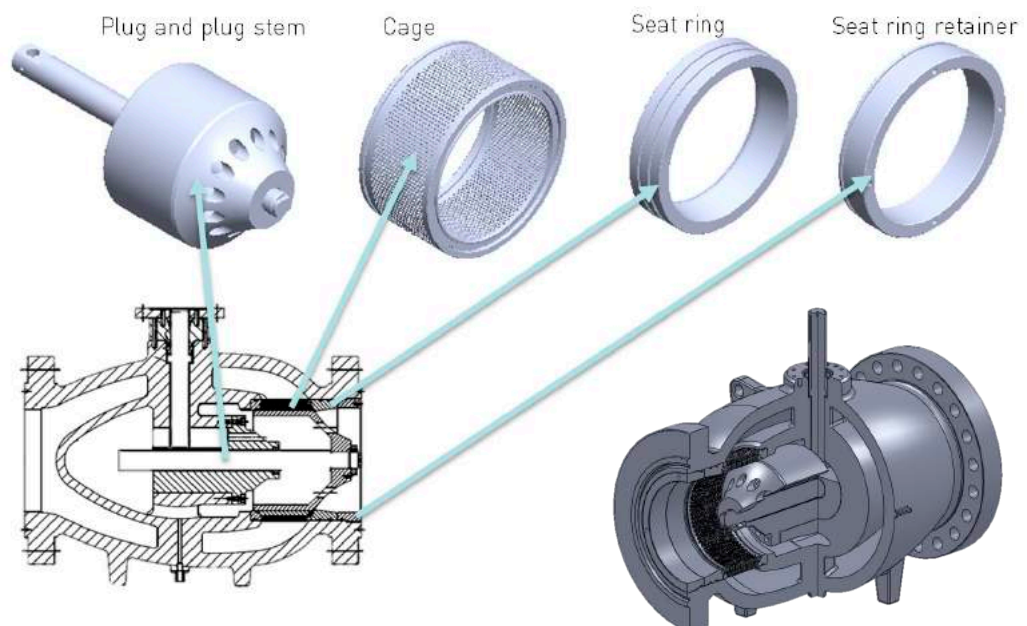



■ Drive Mechanism Design

- Multiplier effect reduces force torque and actuator size.
- It is not affected by dirt, impurities or fluid conditions.
- No gap, low friction bushings in crank and rod junctions assure a smooth, no backlash movement of the plug.
- The drive mechanism is designed to multiply the actuator force applied to the plug when it is needed. This feature makes it possible to select lower torque, smaller size actuator and reduce operating times.
- Additionally it improves the valve inherent rangeability. At the beginning of the opening a large angle of rotation means a small change in the stroke of the plug. Good for start-up conditions with small cv values.

- All together it combines to give smooth, accurate fast operation of the valve with smaller size actuator and enhanced rangeability.

Main features of our rotary to linear drive mechanism are:

- Low friction sealing of rotating shaft
- Low friction bearings in the transmission of movement, from shaft to plug stem.
- Plug, guided by the stem is fully balanced in both axial and radial directions and gives no friction to cage.
- Multiplier effect that reduces the required actuation force.
- Maximum force is delivered when it is most needed at opening and closing.
- All the above combine to greatly reduce the torque, the size of the actuator and the operating time.

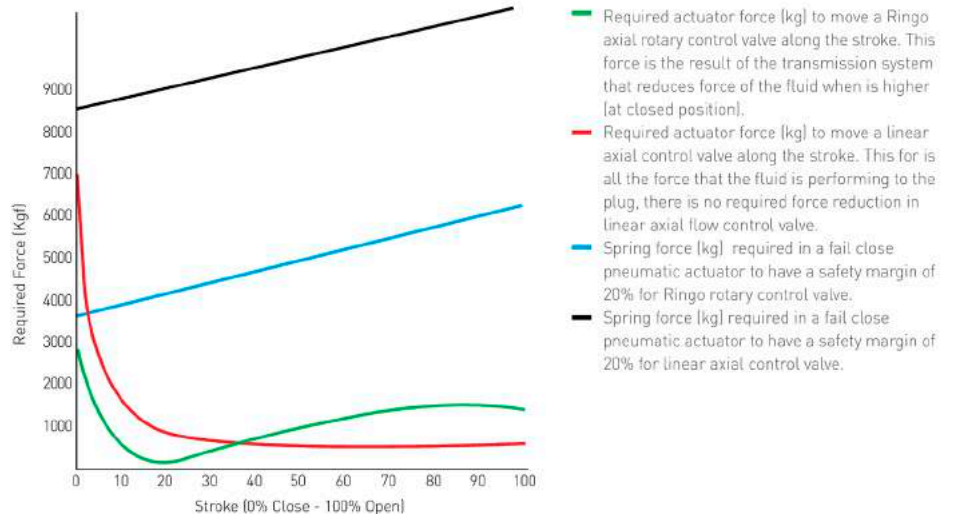

It can be seen in the graph the comparison of a linear to linear axial flow control valve versus the Ringo linear to rotary axial flow control valve. Fluid required force at closing position can be several times higher than in all other stroke points. The rotary axial flow valve from Ringo provides force required reduction at closing position, which is when more is needed. With the consequence of a reduced actuator size for the same process conditions.

■ Additional advantages of our driving mechanism are:

Standard 90° rotary, pneumatic or electric actuator of any manufacturer can be used. Hysteresis reduced due to perfect adjustment in mechanism (minimum clearance). Reduced fugitive emissions, due to the benefits of a rotary stem versus linear stem.

Excellent behavior in dirty fluids. Stem guided design allows increasing the gap between cage and plug when media includes particles. In addition, all the connections between their components are protected against particles.

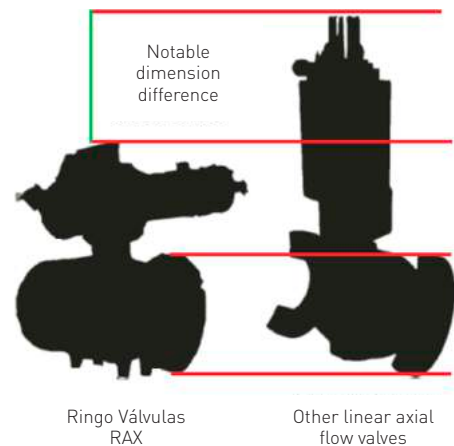

03 Cages Types

We have a complete range of characterized cages to cope with the problems resulting from high pressure drop applications.

Selection of proper internals type allows cavitation supression as well as noise reduction.

Large valve capacity and increased rangeability cages permit the use of one single valve for all process conditions.

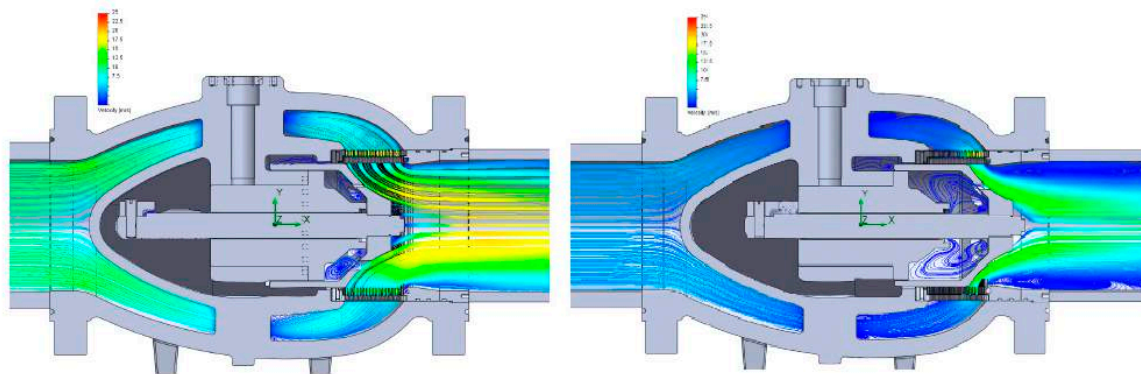

■ On-off applications

Largest flow capacity of axial valves in the market.
As example a 16" 600# valve has been tested to give a Cv value of 12.445, compared with 9.325 and lower values of other manufacturers for the same size and pressure class. Therefore we can achieve either smaller size valves or lower pressure drop.
As an alternative a reduced travel will allow smaller actuator and shorter operating time.

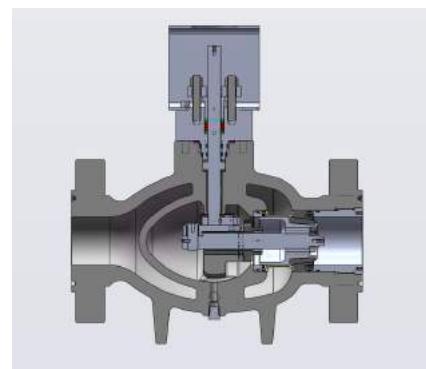

■ Control applications

A variety of single or multiple cages are available to cope with the most stringent requirements in critical applications, such as suppressing cavitation or reducing noise.
Extensive experience in the manufacture of heavy duty control valves has been successfully applied to axial control valves.
Linear, equal percent or other characteristic on request, standard or low noise,
Single double and multiple stage cages or discs, giving recovery factors (FL) as high as 0,99 to cope with the most critical service conditions.

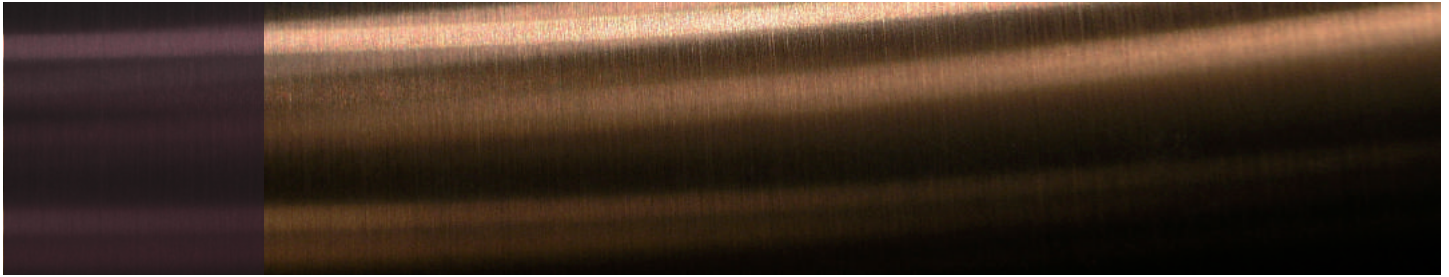

■ STD Cage

Multi-hole cage for non-critical services with regulation purposes

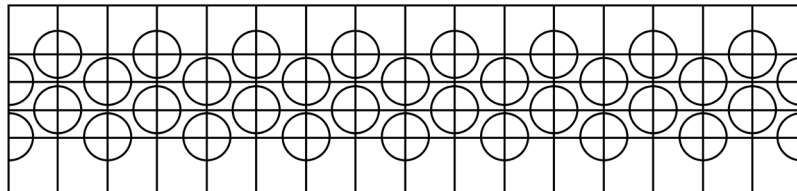

■ LDB (LOW_{dB}):

Multi-hole cage with small hole pattern to reduce noise level by decreasing jet diameter and increasing f_p .

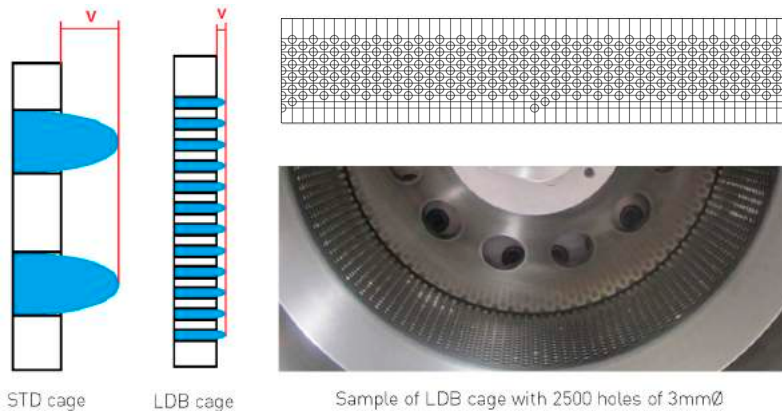

■ DobDrill

Combination of LDB at low strokes and STD at large strokes in order to increase valve rangeability.

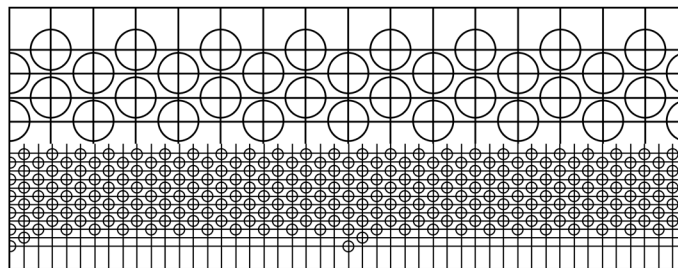

■ DobCage

Combination of two LDB cage with small expansion area in between, in order to ensure the maximum anti-noise protection by multi-stage effect.

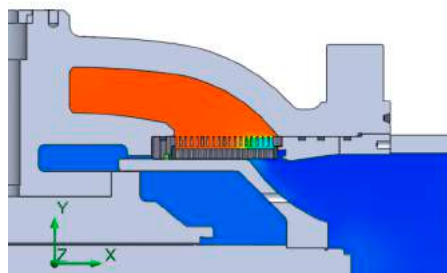

More than 2 stages (up to 4 can also be provided for special services with high critical noise levels if requested)

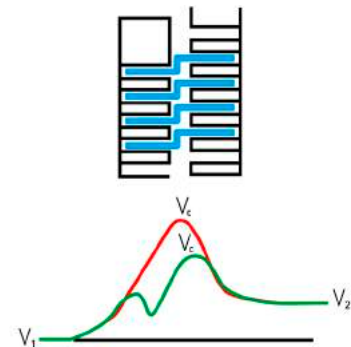

04 Codification System

■ Body

	Valve Size
04	4" DN100
06	6" DN150
08	8" DN200
10	10" DN250
12	12" DN300
14	14" DN350
16	16" DN400
18	18" DN450

	Valvet Size
20	20" DN500
24	24" DN600
28	28" DN700
30	30" DN750
36	36" DN900
40	40" DN1000
42	42" DN1050
48	48" DN1200

	Rating
1	ANSI 150 PN 10/16/25
2	ANSI 300 PN40
4	ANSI 600
5	ANSI 900
6	ANSI 1500
7	ANSI 2500

	End Connections
1	ANSI Flanged R/F
2	DIN Flanged
5	ANSI Flanged RTJ
x	Custom

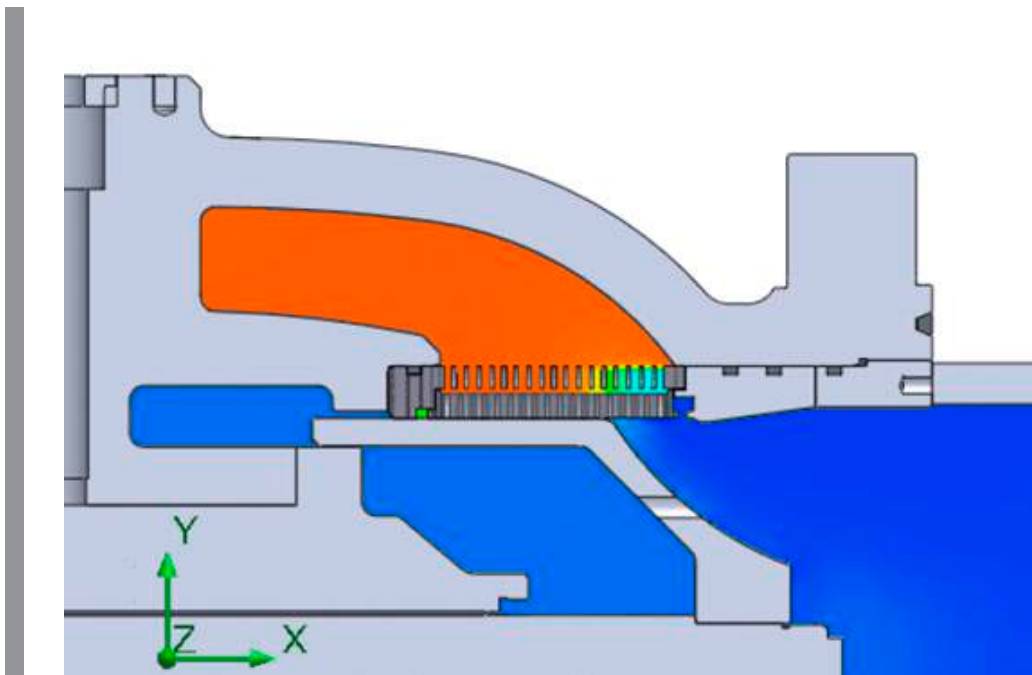

12

Axial

■ Body

	Body Material
3	ASTM A182 F316
4	ASTM A216 WCB
5	ASTM A536
x	Custom

Available only with equal-percentage characteristic

■ Actuator

	Packing Material
1	Graphoil
2	Teflon
3	V-Pack

	Actuator Type
D	Pneumatic
E	Electric
G	Gear operated
H	Hydraulic
L	Lever operated
P	Pneumatic Piston

■ Internals

	Cage Type
0	Quick Opening
1	STD
3	LDB
4	DobCage
7	Special

	Trim Characteristic
3	Linear
4	Equal percentage

	Trim Materials
1	410 Corrosion resistance Steel
2	420 Corrosion resistance Steel
3	316 Stainless Steel
x	Custom

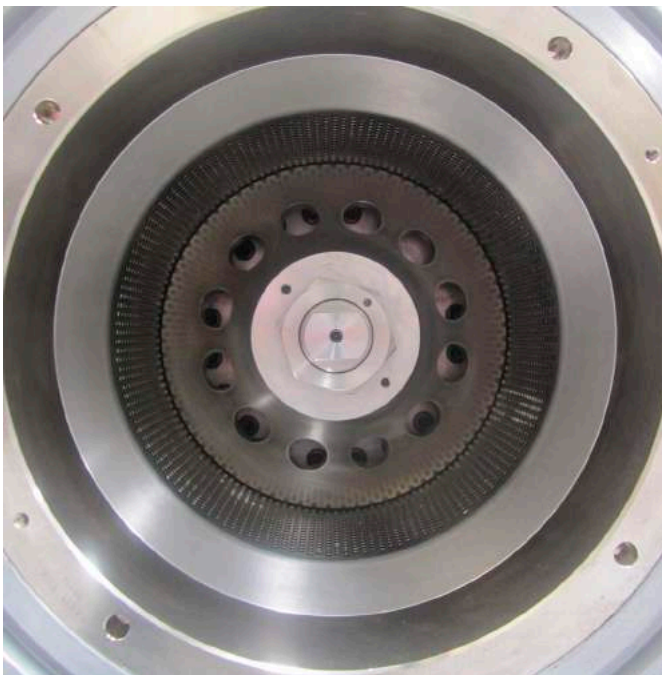

05

Manufacturing Range



■ Gate

Standards	Sizes	Features Design - Materials
ANSI B16.34 API 600 API 6D BS - 1414	1/2"-72" 150# 1/2"-64" 300# 1/2"-48" 600# 1/2"-42" 900# 1/2"-36" 1500# 1/2"-30" 2500# 1/2"-24" 4500#	<p>Types: Wedge Gate/ through conduit / Double expanding</p> <p>Construction: Bolted bonnet / Pressure seal</p> <p>Disc type: Solid / Flexible/ Split /Parallel slide</p>
API 6A	2-1/16"- 7 1/16" 2000 psi 2-1/16"- 7 1/16" 3000 psi 2-1/16"- 9" 5000 psi 1-13/16"- 7 1/16" 10000 psi 1-13/16"- 5-1/8" 15000 psi 1-13/16"- 3-1/16" 20000 psi	<p>Standard features: OS&Y / Backseat</p> <p>Optional features: Lantern ring Equalizer Locking device Stem extension Leak-Off & Packing Expulsor Low emission packing Non rising stem Bellows seal gate</p> <p>Materials: Cast and forged</p> <p>Operation: Manual / MOV / AOV / HOV / Electrohydraulic</p>



■ **Globe**

Standards	Sizes	Features Design - Materials
ANSI B16.34 BS 1873	1/2" -48" 150#-300# 1/2" -42" 600# 1/2" -36" 900# 1/2" -30" 1500# 1/2" -24" 2500# 1/2" -12" 4500#	<p>Types: Straight pattern / Y pattern / Angle pattern / 3-Way / Stop check</p> <p>Construction: Bolted bonnet / Pressure seal</p> <p>Disc type: Flat / Parabolic / Needle</p> <p>Standard features: OS&Y / Backseat</p> <p>Optional features: Lantern ring Leak-Off & Packing Expulsor Locking device Stem extension Low emission packing Bellows seal Zero stem leakage</p> <p>Materials: Cast and forged</p> <p>Operation: Manual / MOV / AOV / HOV / Electrohydraulic</p> 

■ Check

Standards	Sizes	Features Design - Materials
ANSI B16.34 API 6D BS 1868	1/2"-72" 150# 1/2"-64" 300# 1/2"-56" 600# 1/2"-48" 900# 1/2"-36" 1500# 1/2"-30" 2500# 1/2"-24" 4500#	<p>Types: Swing check / Dual plate / Tilting Disc / Piston check / Ball check / Single Disc / Axial check</p> <p>Construction: Bolted bonnet / Pressure seal Wafer / Lug / Double flanged</p> <p>Optional features: Position indicator Locking device Emergency assisted valves Dumpered valves</p> <p>Materials: Cast and forged</p>
API 6A	2-1/16" - 11" 2000 psi 2-1/16" - 11" 3000 psi 2-1/16" - 11" 5000 psi 1-13/16" - 7 1/16" 10000 psi 1-13/16" - 4 1/16" 15000 psi 1-13/16" - 3-1/16" 20000 psi	

■ Butterfly (on-off and control)

Standards	Sizes	Features Design - Materials
AWWA C-504	40"-120" CLASS 25A-250A	<p>Types: Concentric Double eccentric Triple eccentric</p> <p>Seats: Soft / Metal Seated</p> <p>Construction: Wafer / Lug / Double flanged</p> <p>Materials: Cast and forged</p> <p>Optional features: Control butterfly valves</p> <p>Operation: Manual / MOV / AOV / HOV / Electrohydraulic</p>
BS - 3952	3"-40" ANSI 600#	

■ **Ball (on-off and control)**

Standards	Sizes	Features Design - Materials
ANSI B16.34 API 6D	1/2"-60" 150#-600# 1/2"-56" 900# 1/2"-48" 1500# 1/2"-30" 2500#	<p>Types: Trunnion Mounted / Floating</p> <p>Construction: Side entry Split body: 2 or 3 pieces Fully welded Top entry</p> <p>Seats: Soft / Metal Seated</p> <p>Standard features Trunnion: Bidirectional Flow Trunnion Design for low torque Automatic cavity pressure relief Double block & bleed Anti-blow out stem Grease fittings, drain and vent Antistatic device Fire safe</p> <p>Optional features: Double piston effect Seat with scrapper Locking device Stem extension Low emission packing Live loaded packing 3-Way ball valves Control ball valves High temperature service</p> <p>Materials: Cast and forged</p> <p>Operation: Manual / MOV / AOV / HOV / Electrohydraulic</p>
API 6A	2-1/16" - 7 1/16" 2000 psi 2-1/16" - 7 1/16" 3000 psi 2-1/16" - 7 1/16" 5000 psi 1-13/16" - 7 1/16" 10000 psi 1-13/16" - 5-1/8" 15000 psi 1-13/16" - 3-1/8" 20000 psi	

■ Choke

Standards	Sizes	Features Design - Materials
API 6A	Customized up to 20000 psi	<p>Types: Positive, Adjustable and Control</p> <p>Materials: Cast and forged</p> <p>Operation: Pneumatic diaphragm Pneumatic piston Hydraulic piston Electrohydraulic</p> 

■ Axial flow valves (on-off and control)

Standards	Sizes	Features Design - Materials
ASME B16.34	4"-48" 150#-900# 4"-24" 1500#	<p>Types: One piece body</p> <p>Trim type: STD / LDB / DobDrill / DobCage</p> <p>Materials: Cast</p> <p>Operation: Manual Pneumatic Hydraulic Electric Electrohydraulic</p> 

■ **Globe control - cage guided**

Standards	Sizes	Features Design - Materials
ANSI B16.34	1/2"-36" 150#-300# 1/2"-30" 600# 1/2"-28" 900 1/2"-24" 1500# 1/2"-20" 2500# 1/2"-12" 4500#	<p>Types: Straight pattern / Y pattern / Angle / 3-Way / Bellows seal</p> <p>Construction: Bolted bonnet / Pressure seal</p> <p>Trim type: Mini flow / Multistep / USS STD / USS LDB BSS STD / BSS LDB Pilot / Multicylinder / Cascade</p> <p>Standard features: OS&Y / Backseat</p> <p>Optional features: Lantern ring Leak-Off & Packing Expulsor Double packing Stem extension Low emission packing Bellows sealed control globe</p> <p>Materials: Cast and forged</p> <p>Operation: Pneumatic diaphragm / Pneumatic piston / Hydraulic piston / Electric Electrohydraulic</p> 



API 6A-0729
Licence Nr. 6A-0729



API 6D-0495
Licence Nr. 6D-0495



API 6DSS-0038
Licence Nr. 6DSS-0038



Polígono Empresarium.
c/ Romero, 6 - 50720 Zaragoza (Spain)
Tel. +34 976 45 49 40 - Fax. +34 976 45 48 40
ringo@ringospain.com - www.ringospain.com

Catalogue number: PRD-VAXL-ING-001-R0 Date: 28/07/2016